

# Seismic design of beam-column joints in RC moment resisting frames – Review of codes

S. R. Uma<sup>†</sup>

*Department of Civil Engineering, University of Canterbury, New Zealand*

Sudhir K. Jain<sup>‡</sup>

*Department of Civil Engineering, Indian Institute of Technology Kanpur, Kanpur, India*

*(Received January 14, 2005, Accepted March 16, 2006)*

**Abstract.** The behaviour of reinforced concrete moment resisting frame structures in recent earthquakes all over the world has highlighted the consequences of poor performance of beam column joints. Large amount of research carried out to understand the complex mechanisms and safe behaviour of beam column joints has gone into code recommendations. This paper presents critical review of recommendations of well established codes regarding design and detailing aspects of beam column joints. The codes of practice considered are ACI 318M-02, NZS 3101: Part 1:1995 and the Eurocode 8 of EN 1998-1:2003. All three codes aim to satisfy the bond and shear requirements within the joint. It is observed that ACI 318M-02 requires smaller column depth as compared to the other two codes based on the anchorage conditions. NZS 3101:1995 and EN 1998-1:2003 consider the shear stress level to obtain the required stirrup reinforcement whereas ACI 318M-02 provides stirrup reinforcement to retain the axial load capacity of column by confinement. Significant factors influencing the design of beam-column joints are identified and the effect of their variations on design parameters is compared. The variation in the requirements of shear reinforcement is substantial among the three codes.

**Keywords:** anchorage; beam-column joint; bond; code provisions; reinforced concrete frames; shear reinforcement.

---

## 1. Introduction

Beam column joints in a reinforced concrete moment resisting frame are crucial zones for transfer of loads effectively between the connecting elements (i.e., beams and columns) in the structure. In normal design practice for gravity loads, the design check for joints is not critical and hence not warranted. But, the failure of reinforced concrete frames during many earthquakes has demonstrated heavy distress due to shear in the joints that culminated in the collapse of the structure. Detailed studies of joints for buildings in seismic regions have been undertaken only in the past three to four decades. It is worth mentioning that the relevant research outcomes on beam column joints from

---

<sup>†</sup> Research Assistant (Formerly, Project Officer, Dept. of Civil Eng., I. I. T. Madras, India)

<sup>‡</sup> Professor, Corresponding author, E-mail: [skjain@iitk.ac.in](mailto:skjain@iitk.ac.in)

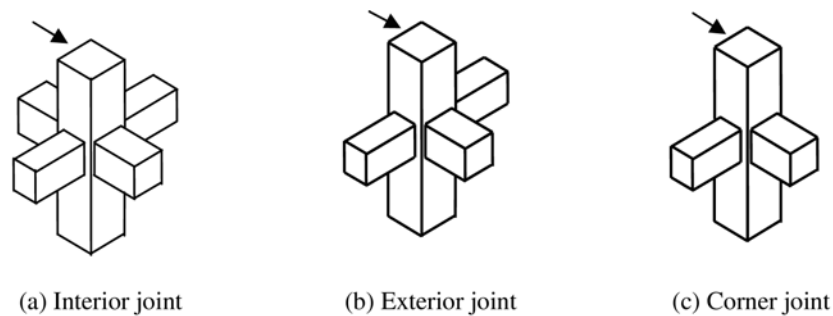

Fig. 1 Types of joints in a moment resisting frame

different countries have led to conflicts in certain aspects of design. Coordinated programmes were conducted by researchers from various countries to identify these conflicting issues and resolve them (Park and Hopkins 1989). Nevertheless, it is imperative and informative to bring out the critical aspects with respect to design of seismic joints adopted by various international codes of practice.

This paper presents a comprehensive review of the design and detailing requirements of interior and exterior joints of special moment resisting reinforced concrete frames, with reference to three codes of practices: American Concrete Institute (ACI 318M-02), New Zealand Standards (NZS 3101:1995) and Eurocode 8 (EN 1998-1:2003). The discussions with respect to Eurocode are pertaining to 'High' ductility class defined by that code.

## 2. Joints in reinforced concrete moment resisting frames

Beam column joints are generally classified with respect to geometrical configuration and identified as interior, exterior and corner joints as shown in Fig. 1. Theoretical background on design of beam column joints has been reviewed in a number of publications (e.g., Uma and Meher Prasad 2005). There are basic differences in the mechanisms of beam longitudinal bar anchorages and the shear requirements in two types of joints such as interior joint and exterior joints in relevance to code recommendations. With respect to the plane of loading, an interior beam-column joint consists of two beams on either side of the column and an exterior beam-column joint has a beam terminating on one face of the column.

## 3. Design approach by codes

In reinforced concrete moment resisting frame structures, the functional requirement of a joint, which is the zone of intersection of beams and columns, is to enable the adjoining members to develop and sustain their ultimate capacity. The demand on this finite size element is always severe and more complex due to the possible two-way actions in three-dimensional frame structures. However, the codes consider one direction of loading at a time and arrive at the design parameters for the joint.

### 3.1 General criteria

The basic requirement of design is that the joint must be stronger than the adjoining hinging members, usually the beams or columns. It is important to ensure early in the design phase that the joint size is adequate, otherwise the column or beam size may need to be subsequently changed to satisfy the joint strength or anchorage requirements. Judicious detailing of reinforcement is of paramount importance to ensure that the full strength of reinforcing bars, serving either as principal flexural or transverse reinforcement, can be mobilized. In a global sense, the design procedure of beam-column joints consists of the following steps:

- Arrive at the preliminary size for members based on anchorage requirements for the chosen longitudinal bars.
- Ensure adequate flexural strength of columns to get the desired beam yielding mechanism.
- Arrive at the design shear force for the joint by evaluating the flexural overstrength of the adjacent beams and corresponding internal forces in columns that maintain equilibrium.
- Obtain effective joint shear area from the adjoining member dimensions.
- Ensure that the induced shear stress is less than the allowable stress limit. The allowable shear stress limit is expressed as a function of the compressive strength or diagonal tensile strength of concrete. If not satisfied, alter the associated member dimensions.
- Provide transverse reinforcements both as confining reinforcement and as shear reinforcement.
- Provide sufficient anchorage for the reinforcement passing through or terminating in the joint.

The above listed points are elaborated in sequence and discussed in detail with respect to code provisions. In this paper, the variables involved in the code provisions are expressed with the help of commonly adopted notations and symbols, for convenience, and may be different from the specific notations used by the three codes. Considering a large number of notations involved, not all are defined in the main text of the paper but explained in the Appendix.

### 3.2 Member sizes

In seismic conditions involving reversed cyclic loading, anchorage requirements assume great importance in deciding the sizes of the members. Also, the requirement of adequate flexural strength of columns to ensure beam yield mechanism affects the member sizes. The relevant expressions suggested by three codes with regard to development length and flexural strength ratios are summarised in Table 1.

Table 1 Code provisions that influence the size of the members

Parameters	ACI 318M-02	NZS 3101:1995	EN 1998-1:2003
Development length for interior joints	$d_b/h_c \geq 1/20$	$\frac{d_b}{h_c} \leq 6 \left[ \frac{\alpha_1 \alpha_p}{\alpha_s} \right] \alpha_f \frac{\sqrt{f'_c}}{\alpha_0 f_y}$	$\frac{d_b}{h_c} \leq \frac{7.5 f_{ctm}}{\gamma_{Rd} f_{yd}} \frac{1 + 0.8 v_d}{1 + 0.75 k_D \rho' / \rho_{max}}$
Development length for exterior joints	$L_{dh} = \frac{f_y d_b}{5.4 \sqrt{f'_c}}$	$L_{dh} = 0.24 \alpha_b \alpha_1 \alpha_2 \frac{f_y d_b}{\sqrt{f'_c}}$	$\frac{d_b}{h_c} \leq \frac{7.5 f_{ctm}}{\gamma_{Rd} f_{yd}} (1 + 0.8 v_d)$
Flexural strength of columns	$\sum M_{n,c} \geq 1.2 \sum M_{n,b}$	$\sum_c M_n \geq 1.4 \sum_b \phi_o M_n$	$\sum M_{Rc} \geq 1.3 \sum M_{Rb}$

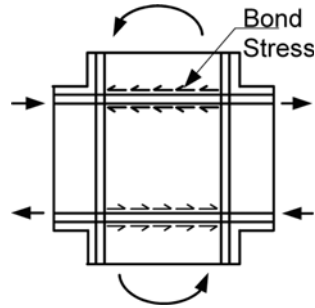

Fig. 2 Bond condition in an interior joint

3.2.1 Depth of member for interior joint

In an interior joint, the force in a bar passing continuously through the joint changes from compression to tension causing push-pull effect with distribution of bond stress as shown in Fig. 2. The severe demand on bond strength necessitates that adequate development length for the bar be made available within the depth of the member. In recognition of this, the codes limit the ratio between the largest bar diameter and the member depth expressed as  $(d_b/h_c)$  ratio. This limit is to provide reasonable control on the amount of potential slip of the longitudinal bars through the joint that can eventually reduce the stiffness and energy dissipation capacity of the connection region. Longer development lengths are desirable, particularly when associated with high shear stresses and low values of ratio of column flexural strength to beam flexural strength (Leon 1990). The axial compression load on column improves the confinement of joint core to some extent which improves the bond condition within joint core (Paulay and Priestley 1992). The codes NZS and EN recognize contributions from various factors such as effect of axial load, material strength and ratio of compression to tension reinforcement whereas ACI gives the ratio as a constant (Table 1).

Expressions of  $(d_b/h_c)$  for interior joint by the three codes are given in Table 1. More details on NZS code expression can be found elsewhere (Hakuto *et al.* 1999). Three important parameters influencing the column depth are bar diameter,  $d_b$ , concrete compressive strength,  $f_c'$  and normalized

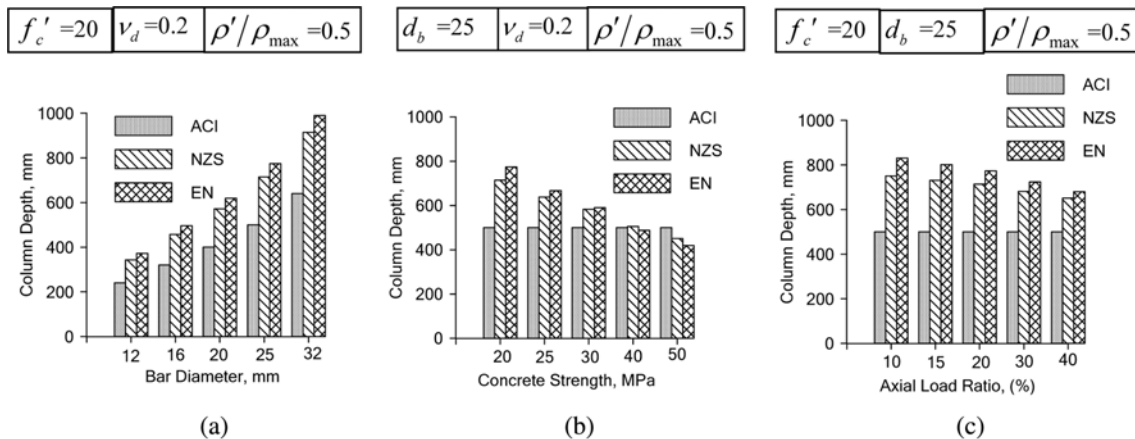

Fig. 3 Variation of column depth for interior joint

axial force ratio on column,  $v_d$ . The effect of each parameter on column depth has been compared by keeping the other two as constants. Fig. 3(a) shows variations in required column depths with diameter of beam bars. EN code consistently shows larger column depth requirements. The  $(d_b/h_c)$  ratios are 0.05, less than 0.0345 and less than 0.0322 for ACI, NZS and EN codes respectively.

Fig. 3(b) shows the variation in required column depth with concrete grade. ACI does not consider the concrete strength and hence the column depth required remains constant. NZS reduces the depth of column moderately with increase in concrete grade whereas the rate of reduction is higher as per EN code. The effect of axial load included in the determination of column depth by NZS and EN codes is shown in Fig. 3(c). NZS provision accounts for a reduction of 4.5% and EN expression reduces up to 6% for 10% increase in column axial load ratio. The above comparisons indicate that the ACI provision is less conservative as compared to NZS and EN codes except when the grade of concrete is considerably higher.

### 3.2.2 Depth of member for exterior joint

Fig. 4 shows the typical anchoring of beam bars and the bond deterioration in an exterior joint. The anchorage and development length of the bars within the joint is usually defined with respect to a critical section located at a distance from the column face where the bars enter into the joint. The critical section refers to the section from where the development length would be considered effective and not affected by yield penetration and deterioration of bond. Fig. 4(b) self explains the values adopted by the three codes. The expressions for horizontal development length required for exterior joints by the three are shown in Table 1.

For the comparison study on the variation of column depth for exterior joints, the parameters in the expressions of each codes are assumed to have favourable conditions so that column depth arrived are the minimum possible. The development length,  $L_{dh}$  is measured from the critical sections and the column depth is arrived adding a concrete cover of 40 mm.

The deviation in the values of required minimum column depth may be attributed to the difference in the critical section consideration. As per ACI and NZS codes, the horizontal development length required is  $17d_b$  and  $21d_b$  respectively. While it is of more relevance to compare the column depth required for a given bar diameter, it is observed that  $(d_b/h_c)$  will not be a constant ratio and the ratio is slightly high for smaller diameter bars than for larger diameter bars

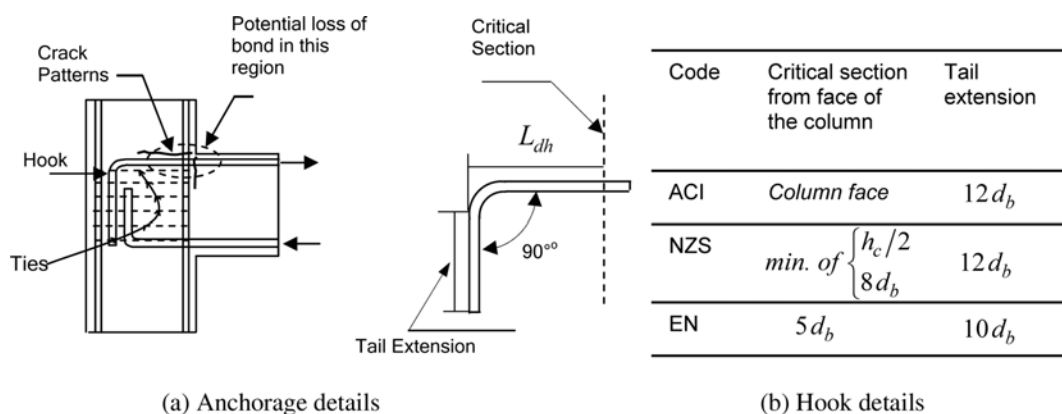

Fig. 4 Details of exterior joint

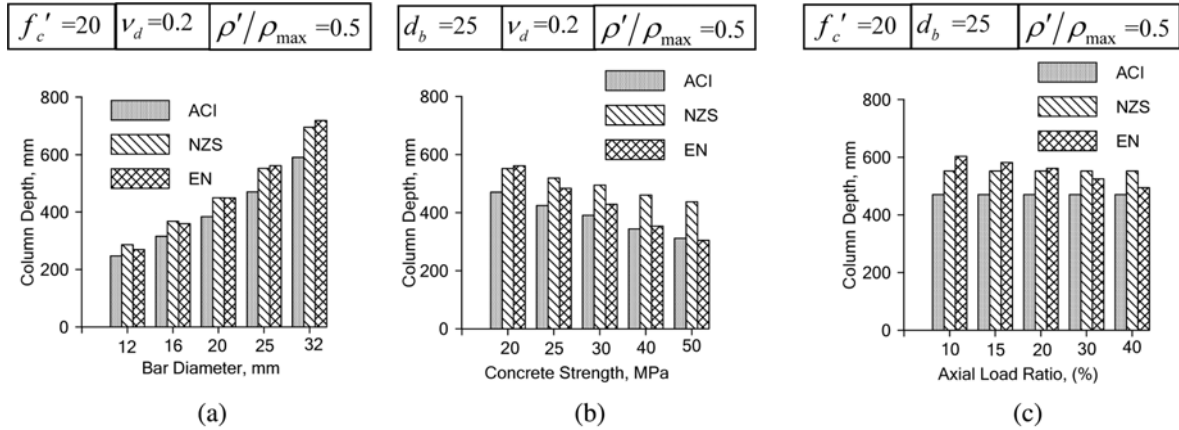

Fig. 5 Variation on column depth for exterior joint

for obvious reasons. Fig. 5(a) shows that the column depths required are around  $19d_b$  and  $23d_b$  for ACI and NZS codes respectively. EN code gives a constant column depth equal to  $22.4d_b$ . The effect of higher concrete strength in reducing the depth of column is largely reflected in EN code provisions than the other two codes as shown in Fig. 5(b). The effect of axial load is not considered by ACI and NZS in predicting  $L_{dh}$  and hence column depth remains constant. However, EN code shows a reduction of 6% in column depth for 10% increase in axial load ratio and is shown in Fig. 5(c).

### 3.3 Flexural strength of columns

The codes give a design check expressions to preclude formation of plastic hinges in columns which essentially aim at ensuring the design values of the moments of resistance of columns more than that of beams including overstrength factors. The NZS performs the check with respect to the centre of the joint including the moments due to the shears at the joint faces apart from the moments acting on the faces of the joint. However, ACI and EN codes accept the check considering only the latter as the loss in accuracy is minor and the simplification achieved is considerable if the shear allowance is neglected. With regard to the flexural strength of column being influenced by the axial load acting on it, all three codes consider axial load that resulted in the minimum flexural strength. Table 1 gives the checks suggested by each code where ACI and NZS provisions compute the nominal flexural strengths of the members and EN code checks with the design values of minimum moment of resistance.

NZS code requirement is given with overstrength factor for beams,  $\phi_o$ , which may be taken as 1.47 from the overstrength of steel as 1.25 and a strength reduction factor of 0.85. The dynamic magnification of column moments derived for lateral static forces are likely at higher modes and is represented by 1.4 for one-way frames (Paulay and Priestley 1992). Hence it can be understood that the design flexural strength of columns are expected to be at least 2.06 times higher than the design flexural strength of adjoining beams. This factor is much greater than those suggested by ACI and EN codes.

### 3.4 Shear force acting on the joint

The horizontal shear forces,  $V_{jh}$  and the vertical shear forces,  $V_{jv}$  in the joint are basically arrived from the internal forces associated with hinging conditions in the adjoining members. With the assumption that the beams are designed for plastic hinge formations, the column shear can be calculated as per the following equations where,  $M_{1o}$  and  $M_{2o}$  are the flexural overstrength capacities of beams including the contribution of floor slab on either side of the joint.

$$V_{col} = \frac{M_{1o} + M_{2o}}{(l'_c + l_c)/2} \quad (1)$$

The shear force demand,  $V_{jh}$ , in the horizontal direction can be obtained as the net force acting on a horizontal plane across the joint so as to include the forces from the beam and the shear force in the column.

$$V_{jh} = (A_{s1} + A_{s2})\alpha_o f_y - V_{col} \quad (2)$$

where,  $A_{s1}$  is top reinforcement in the beam including reinforcement in effective flange width and  $A_{s2}$  is bottom reinforcement in the beam.

Similarly, consideration of equilibrium of vertical forces at the joint would lead to expressions for the vertical joint shear force,  $V_{jv}$ . However, because of the multilayered arrangement of the column reinforcement, the derivation of vertical stress resultant is more cumbersome. With assumption of uniform distribution of the stresses along each face of the joint the shear stresses in horizontal and vertical directions of the joint should equal each other. Hence, for common design situations, it is generally considered sufficiently accurate to estimate vertical joint shear force in proportion to horizontal shear force and can be written as

$$\frac{V_{jh}}{b_j h_c} = \frac{V_{jv}}{b_j h_b} \Rightarrow V_{jv} = (h_b/h_c) V_{jh} \quad (3)$$

### 3.5 Shear strength of joint

The shear forces in vertical and horizontal directions develop diagonal compressive and tensile forces within the joint core. Conflicting views on shear transfer mechanisms and design parameters of the joint exist between researchers because of the interplay of shear, bond and confinement within the joint. The model proposed by Paulay *et al.* (1978) considers that the total shear within the joint core being partly carried by a diagonal concrete strut (Fig. 6(a)) and partly by an idealized truss consisting of horizontal hoops, intermediate column bars and inclined concrete bars between diagonal cracks (Figs. 6(b),(c)). The strut mechanism is associated with a diagonal force,  $D_c$  within the concrete strut developed by major diagonal concrete compression forces formed at the corners of the joint and is contributing to the substantial portion of total shear. However, the strength of the strut is reduced by tensile strains developed in perpendicular direction of the strut wherein the confinement of the joint core helps in improving the strength of the strut. The steel forces transferred through bond are introduced into concrete at the four boundaries of the joint core forming a compression field with diagonal cracks in the joint and generate a total diagonal compression force,  $D_s$  as shown in Fig. 6(b). The mechanism associated is called truss mechanism

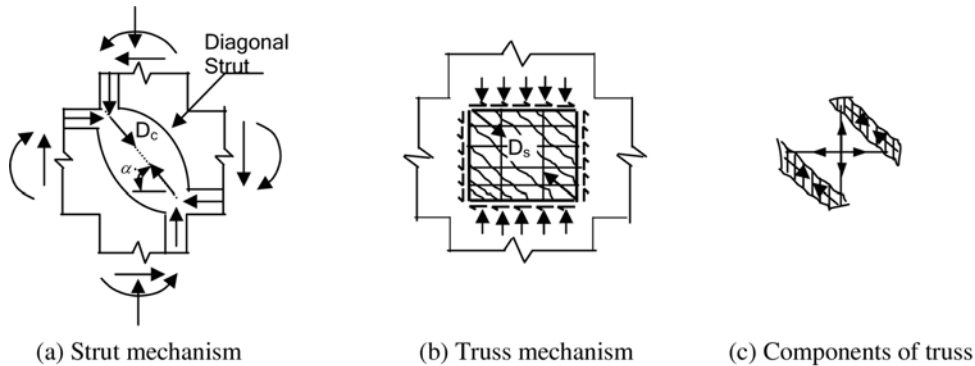

Fig. 6 Shear resisting mechanisms

and is supported by well distributed transverse reinforcement of joint as shown in Figs. 6(b) and (c). The diagonal forces,  $D_c$  and  $D_s$  are acting at an angle  $\alpha$  with respect to the horizontal axis of the joint. The sum of horizontal and vertical components of these forces from both mechanisms gives an estimate of shear resistance in the respective direction.

When the core concrete is thoroughly cracked so that no more diagonal tensile stresses can be transferred by concrete, the transverse reinforcements resist shear as shown in Fig. 6(c). In such situations the contribution of truss mechanism becomes significant, provided good bond conditions are sustained.

In essence, the design of joint to resist the shear force demand is associated with adopting adequate joint dimension to support the strut mechanism and providing adequate transverse reinforcement to take care of truss mechanism. On the other hand, the truss mechanism tends to diminish in case of bond deterioration and the transverse reinforcements can no longer be utilized for taking up joint shear. Hence, for design considerations, the compressive strength of the diagonal concrete strut is considered as the reliable source of strength and based on which the codes define nominal shear capacity of the joint. The nominal shear capacity is expressed in terms of allowable stress in concrete and effective joint area,  $A_j$  (Ref. 3.6). As the first design step it is verified that the shear force demand in the joint is less than the nominal shear capacity, else the dimensions of the joint are to be revised irrespective of the amount of reinforcement available within the joint. Increased joint dimensions improve the strength of strut by increasing the effective joint area and also by reducing the nominal shear stress acting on the joint. Secondly, towards the truss mechanism, the joint is provided with necessary shear reinforcement.

### 3.6 Effective joint area

The effective joint area,  $A_j$  is the area resisting the shear within the joint and is contributed by the framing members in the considered direction of loading. The depth of the joint,  $h_j$  is taken as equal to the depth of the column,  $h_c$ . The width of the joint,  $b_j$  as per different codes is given in Table 2. ACI code uses the distance of the column edge beyond the edge of the beam denoted as  $x$ , which is considered in the direction of loading. However, in any case the joint area,  $A_j$  is not to be taken as greater than the column cross sectional area. NZS and EN codes give identical expressions to determine the width of joint.



Table 2 Effective width of joint,  $b_j$

Sl. No	Category	ACI	NZS	EN
1	$b_c > b_b$	$\min\{b_b + h_c ; b_b + 2x\}$	$\min\{b_c ; b_b + 0.5h_c\}$	$\min\{b_c ; b_b + 0.5h_c\}$
2	$b_b > b_c$	$b_c$	$\min\{b_b ; b_c + 0.5h_c\}$	$\min\{b_b ; b_c + 0.5h_c\}$

### 3.7 Nominal shear stress of the joint

The level of shear stress is an important factor affecting both strength and stiffness of the joint. The codes restrict the nominal shear stress depending on the compressive strength of concrete and axial load acting on the column.

#### 3.7.1 Effect of compressive strength of concrete on nominal shear stress

All three codes evaluate the nominal shear capacity based on strut mechanism and express it as a function of concrete strength irrespective of the amount of shear reinforcement. However, the nominal shear capacity is influenced by the confinement provided by the adjoining members. A beam member that frames into a face is considered to provide confinement to the joint if at least the framing member covers three-quarters of the joint. ACI suggests  $1.7\sqrt{f'_c} A_j$  if confined on four faces,  $1.25\sqrt{f'_c} A_j$  if confined on three faces and  $1.0\sqrt{f'_c} A_j$  for other cases. The NZS has suggested a limiting value of  $0.2 f'_c A_j$ , with respect to strut mechanism irrespective of the confinement offered by the framing members. EN code has limited the nominal shear stress,  $v_{jh}$  within interior beam column joint as per following expression

$$v_{jh} \leq \eta f_{cd} \sqrt{1 - \frac{v_d}{\eta}} \tag{4}$$

where  $\eta = 0.6(1 - f'_c/250)$  denotes the reduction factor on concrete compressive strength due to tensile strains in transverse direction. The shear strength of exterior joints is taken as 80% of the value given by Eq. (4).

The nominal shear stresses calculated on the basis of code recommendations for various grades of concrete are presented in Fig. 7. For interior joints as in Fig. 7(a), NZS consistently yields

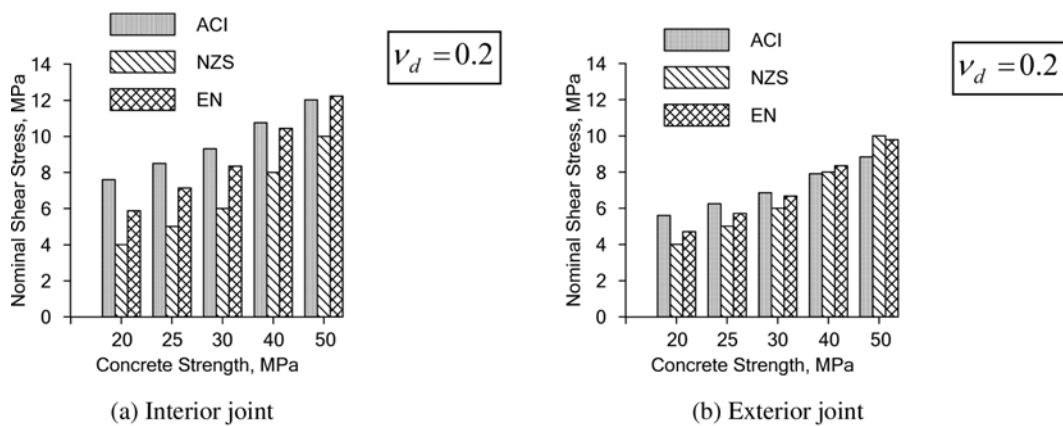

Fig. 7 Effect of concrete strength on nominal shear stress

conservative values. ACI code gives a higher estimate of nominal joint shear capacity compared to the other two codes at lower values of concrete strength. For example, for concrete strength of 20 MPa, the nominal shear stress capacity as per ACI is 29% higher than that provided by EN code and 90% higher than that suggested by NZS. At higher values of concrete strength, ACI and EN codes give nominal shear stress about 20% higher than that obtained by NZS.

Fig. 7(b) shows the comparison of nominal shear stress in exterior joint obtained by the three codes. For concrete strength of 20 MPa, ACI prediction is 19% higher than that of EN and 40% higher with respect to NZS code. At higher strength of concrete ACI is conservative compared to the other two codes.

### 3.7.2 Effect of axial load on nominal shear stress

In recent research publications (Hakuto *et al.* 2000, Pampanin *et al.* 2002) the significance of representing joint capacity in terms of principal stresses has been discussed which recognises the axial load acting on the column. A critical situation where the axial load on the column is very large, diagonal compression failure of strut occurring before the first diagonal tensile cracking in the joint has been cautioned. Therefore, it is very essential to account for the axial load effect in limiting the joint nominal shear stress. In this aspect, EN code has gone one step ahead in including this important factor compared to ACI and NZS codes.

As discussed earlier, the failure criteria for joint are usually associated with principal stresses either in terms of diagonal tensile stresses or diagonal compressive stresses of strut exceeding certain values. The nominal shear stresses associated with such principal stresses are expected to vary with respect to the axial load on the column. Fig. 8 compares the code provisions for nominal shear stress for varying axial load ratios for both interior and exterior joints. It can be seen that ACI code allows higher nominal shear stress and NZS code limits to a lesser value, and both are not affected by axial loads. On the other hand, limiting value of nominal shear stress as per EN code decreases as the axial load increases. Especially for exterior joints, where the variation of axial loads acting on the column could be high during seismic event, the limiting value of nominal shear

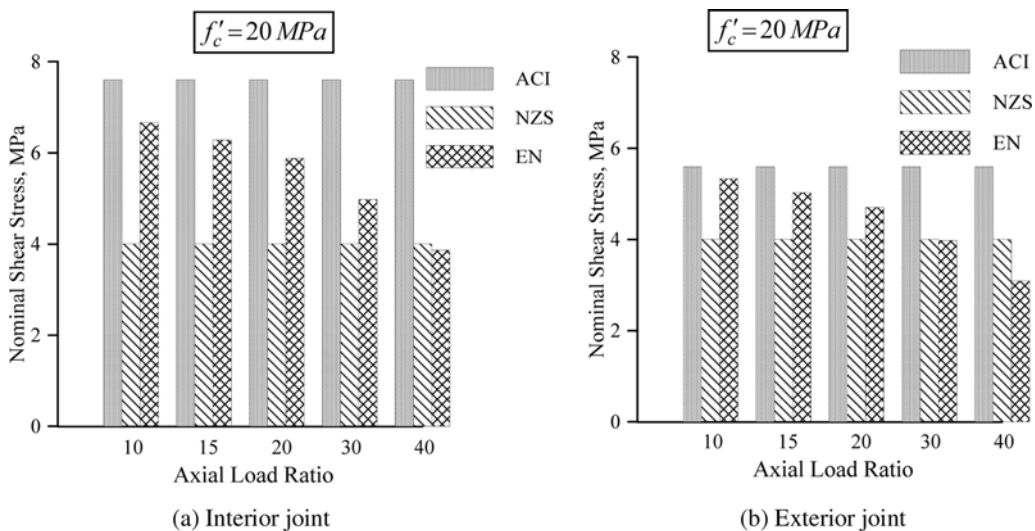

Fig. 8 Effect of axial load on nominal shear stress

stress as per EN code could be less than the “highly conservative value” suggested by NZS and ACI codes.

### 3.8 Design of shear reinforcement

Shear reinforcements for the horizontal shear are supported by stirrups and hoops whereas the vertical shear is taken care adequately by intermediate column bars. Since the intermediate column bars are expected to be in compression, the bars will have adequate strength to take tensile stresses developed during shear resisting mechanism.

Codes suggest expressions for design of shear reinforcement based on the assumption that plastic hinges develop only in the beams. A minimum amount of transverse reinforcement to support the truss mechanism, equivalent to 40% of the total shear demand, has been suggested by NZS code. The provision of joint reinforcement to cater to more than 70% of the total shear does not prevent the compression failure of concrete in the diagonal strut (Ichinose 1991). However, NZS code sets the upper limit such that the nominal shear stress is less than  $0.2 f'_c$ , which corresponds to the strength limit of the diagonal strut.

#### 3.8.1 Horizontal shear reinforcement

ACI code does not require an explicit design for shear reinforcement. Instead, the recommended reinforcement is to confine the joint to maintain the axial load capacity of the column within the core, after the shell becomes ineffective. In rectangular sections the efficiency of confinement provided by rectangular hoops is considered to be 0.75 times that provided by the circular hoops. Thus, the total cross-sectional area of stirrups,  $A_{sh}$ , in each direction of a single hoop, over lapping hoops, or hoops with crossties of the same size in a layer should be at least equal to

$$A_{sh} = 0.3(sh''_c f'_c / f_{yh}) [(A_g / A_{ch}) - 1] \quad (5)$$

but should not be less than

$$A_{sh} = 0.09 \frac{sh''_c f'_c}{f_{yh}} \quad (6)$$

NZS code gives expressions for the total amount of shear reinforcement,  $A_{jh}$  to be distributed within the joint (Eqs. (7) and (9)). The design shear reinforcement for interior joints is arrived at considering the fact that the additional forces from the slab reinforcement,  $A_{sf}$  within the effective flange width are transferred as compressive force to the core concrete and the strut mechanism would be responsible for taking up this additional force. Hence, the shear reinforcement with regard to truss mechanism is to be provided only for the forces from the top reinforcement,  $A_s^*$  (i.e.,  $A_{s1} - A_{sf}$ ), provided within the web portion of the beam. The area of the total joint shear reinforcement,  $A_{jh}$  corresponding to a nominal shear stress,  $v_{jh}$  is given by

$$A_{jh} = \frac{6 v_{jh}}{f'_c} \alpha_j \frac{f_y}{f_{yh}} A_s^* \quad (7)$$

where

$$\alpha_j = 1.4 \quad (\text{or}) \quad \alpha_j = 1.4 - 1.6 \frac{C_j N^*}{f'_c A_g} \quad (8)$$

The second expression in Eq. (8) accounts for the effects of the axial compression load acting on the column thereby reducing the amount of shear reinforcement required.

In exterior joints, the force from slab reinforcements are not transferred to the core concrete and it is to be resisted by truss mechanism only. Hence, it is necessary to consider the total reinforcement,  $A_{s1}$  at the top, inclusive of that from the effective flange width in the calculation of design shear reinforcement which is given by

$$A_{jh} = \frac{6v_{jh}}{f'_c} \beta \left( 0.7 - \frac{C_j N^*}{f'_c A_g} \right) \frac{f_y}{f_{yh}} A_{s1} \quad (9)$$

where  $N^*$  is taken negative with axial tension in which case  $C_j = 1$  must be assumed for one way loaded frames.

The design provisions for shear reinforcement as per Eq. (7) and Eq. (9) ensure a lower limit to support the truss mechanism and an upper limit to prevent compression failure of diagonal concrete strut. These are achieved by restricting  $6v_{jh}/f'_c$  not to be less than 0.85 and not to be more than 1.2.

EN code gives expressions for adequate confinement to be provided to limit the maximum diagonal tensile stress in the core concrete to design value of tensile strength of concrete. The minimum amount of reinforcement is given as

$$\frac{A_{jh} f_{yhd}}{b_j h_{jw}} \geq \frac{\left( \frac{V_{jh}}{b_j h_{jc}} \right)^2}{f_{ctd} + v_d f_{cd}} - f_{ctd} \quad (10)$$

However, the code also imposes a requirement to maintain the integrity of the joint after diagonal cracking and hence the necessary reinforcement to be provide for interior is given as

$$A_{jh} f_{yhd} \geq \gamma_{Rd} (A_{s1} + A_{s2}) f_{yd} (1 - 0.8 v_d) \quad (11)$$

and that for exterior joints is given as

$$A_{jh} f_{yhd} \geq \gamma_{Rd} A_{s2} f_{yd} (1 - 0.8 v_d) \quad (12)$$

An example problem is used here to illustrate the requirements of design shear reinforcement as per the three codes and the details of the joints considered for this study are given in Table 3.

The dimensions of beam and column satisfy the anchorage requirements and the joint has adequate nominal shear capacity. The horizontal shear reinforcement required by three codes was computed for different grades of concrete. The flexural strength of beams has been computed considering the effective slab width suggested by ACI code.

Table 3 Section details of interior and exterior joint

	Column	Beam	Slab
Section	625 mm × 625 mm	500 mm × 625 mm	150 mm thick
Longitudinal reinforcement	12 – 25 mm dia $f_y = 415$ MPa	Top Reinf: 6 – 220 mm dia Bot Reinf: 3 – 220 mm dia $f_y = 415$ MPa	Top: 10 mm dia at 150 mm spacing Bot: 10 mm dia at 200 mm spacing
Height / Span	3500 mm	5000 mm	-

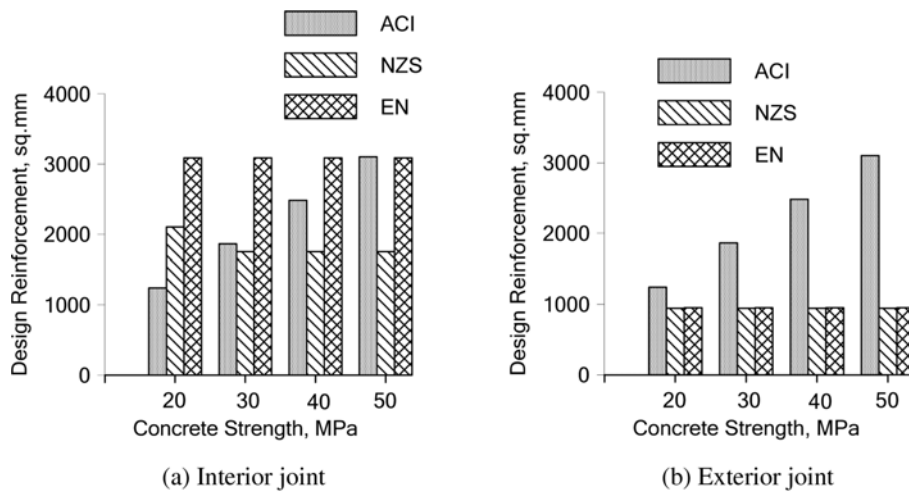

Fig. 9 Effect of concrete strength on design shear reinforcement

#### (a) Interior joint

The design shear reinforcement,  $A_{jh}$ , for the example interior joint as per the three codes is given in Fig. 9(a). ACI code provision as referred in Eq. (5) gives minimum transverse reinforcement required per layer,  $A_{sh}$  and this is repeated within the joint adopting the spacing of 100 mm to arrive at the required amount for the entire joint,  $A_{jh}$ . The amount of reinforcement increases proportional to the grade of concrete. With regard to EN code the reinforcement as per Eq. (10) was not governing in this example problem. Hence the reinforcement as per Eq. (11) has been considered. The expression does not vary with concrete strength except in the parameter,  $\gamma_d$ , representing axial load ratio, which is assumed as 0.2 and hence shear reinforcement is constant. A perusal of the expression given by NZS code indicates that the shear reinforcement is inversely proportional to the strength of concrete. This leads to an interpretation that higher concrete strength would lower the required amount of shear reinforcement within the joint. However, the calculation of shear reinforcement is more affected by the limits on the nominal shear stress in concrete to be satisfied and/or on the condition based on minimum shear force to be resisted by the transverse reinforcement as explained earlier. In the chosen example, the design shear reinforcement required for and above concrete strength 30MPa is governed by the constraint imposed by nominal shear stress ratio  $6v_{jh}/f'_c \geq 0.85$  rather than by 40% of design shear force

It may be observed from the above discussion, ACI code adopts increasing shear reinforcement with the increase in concrete strength and EN code suggests expressions based on the forces on the main reinforcement of the beam members which appears to be more stringent even at the lower strength of concrete. The design shear reinforcement values obtained from NZS code clearly indicate even if strength of concrete is increasing, there is a limit for the shear resisting capacity offered by the strut and truss mechanisms and gives appropriate required amount of design shear reinforcement in the joint.

#### (b) Exterior joint

A comparison on the requirement of design shear reinforcement for exterior joint is done. ACI code recommends Eq. (5) and Eq. (6) both for interior and exterior joints which are independent of

shear demand. Whereas NZS and EN codes propose provisions for shear reinforcement in exterior joints considering shear demand. The design shear reinforcements computed as per the provisions of the three codes are given in Fig. 9(b). ACI code gives constant increase in design reinforcement with increase in concrete strength. EN code gives a constant amount of shear reinforcement irrespective of concrete strength. With regard to NZS code, the shear reinforcement should be based on the values computed either by the condition as  $A_{sh} \geq 0.4 V_{jh}/f_{yh}'$  or as per Eq. (9). In this particular example study, shear reinforcement obtained for 40% of the joint shear demand was governing rather than the values obtained as per Eq. (9). Hence in Fig. 9(b), the required amount of steel remains constant for all grades of concrete as per NZS code.

### 3.8.2 Vertical shear reinforcement

Vertical reinforcements are provided in the form of intermediate column bars placed in the plane of bending between corner bars or vertical stirrup ties or special vertical bars, placed in the column adequately anchored to transmit required tensile force. In seismic design, column hinging is generally precluded and hence column reinforcements are expected to remain elastic. Thereby, vertical joint shear is expected not to be critical compared to horizontal joint shear and codes estimate the vertical shear reinforcement in proportion to the required horizontal shear reinforcement. ACI code does not provide expressions for vertical shear reinforcement. However, the code insists on placement of intermediate column bars with restrictions on spacing on each face of the column. NZS and EN codes give specific recommendations for vertical reinforcement in terms of horizontal shear reinforcement. The expression by NZS code is as follows:

$$A_{jv} = \alpha_v \frac{h_b}{h_c} A_{jh} \frac{f_{yh}}{f_{yv}} \quad (13)$$

where

$$\alpha_v = 0.7 / (1 + N^* / f_c' A_g) \quad (14)$$

Similarly, EN code assumes that the intermediate column bars are subjected to compression approximately equal to  $0.5 f_{yd}$ , thus offering a tensile stress margin of  $1.5 A_{sv,i} f_{yd}$  for shear and suggests the following expression

$$A_{sv,i} = \frac{2}{3} A_{sh} \left( \frac{h_{jc}}{h_{jw}} \right) \quad (15)$$

where  $A_{sv,i}$ , is the total area of the intermediate bars located in the relevant column faces.

The design shear reinforcement required for the vertical joint shear has been compared for interior and exterior joints in Fig. 10(a) and Fig. 10(b) respectively. The values computed as per NZS and EN codes are plotted and ACI code is not included for no specific expression available. EN code requires only 2/3 of the horizontal shear reinforcement as vertical reinforcement whereas NZS code adopts the reduction factor subjective to the axial load acting on the joint. In the example, for a compressive axial load ratio of 0.2, the vertical reinforcement is of about 0.58 times and as per EN code is of about 0.66 times the horizontal shear reinforcement.

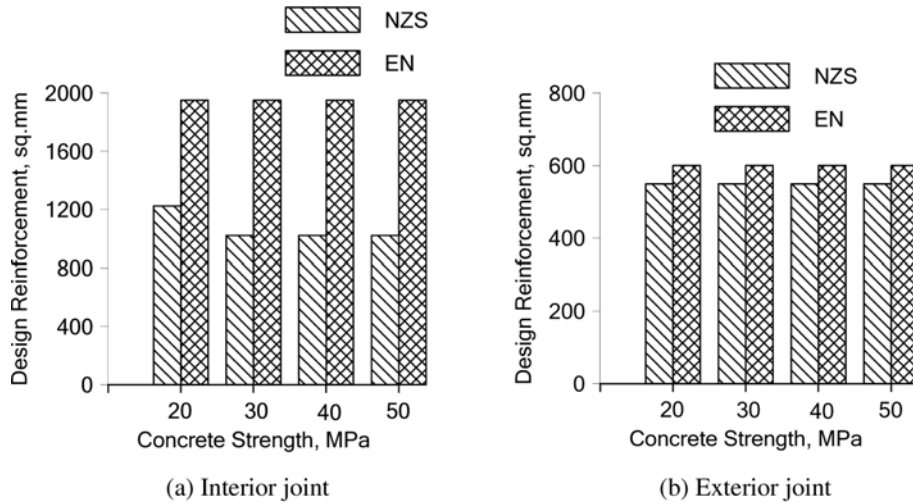

Fig. 10 Vertical design shear reinforcement

Table 4 Spacing requirements for horizontal and vertical transverse reinforcements, mm

Code	Vertical spacing for horizontal stirrups	Horizontal spacing of vertical reinforcement
ACI	$\min\{h_c/4 ; 6 d_b ; s_x\}$	not more than 350
NZS	$\min\{10 d_b ; 200\}^\#$	$\min\{h_c/4 ; 200\}$
EN	$\min\{b_o/2 ; 8 d_b ; 175\}$	150

Note: All dimensions are in mm ;  $s_x = 100 + \left(\frac{350 - h_x}{3}\right)$  where  $100 < s_x < 150$

<sup>#</sup>subject to variation with regard column ties requirement to avoid buckling

### 3.9 Detailing for shear reinforcement

Detailing features relevant to beam-column joints are concerned with aspects such as spacing of longitudinal and transverse reinforcement and development length for embedded bars. The spacing requirements imposed by the three codes are summarized in Table 4. In principle, the restrictions on vertical spacing of transverse reinforcement are given with respect to the least member dimension to obtain adequate concrete confinement and in terms of diameter of longitudinal column bar to restrain buckling of bar after spalling of concrete. The spacing of horizontal lateral reinforcement is relaxed with respect to the confinement offered by the adjoining members and also based on the distribution of column longitudinal reinforcements. It can be seen that the spacing of lateral reinforcement is more or less the same for all the three codes of practice. As per NZS code provisions, the spacing of the lateral reinforcement within the joint is relatively higher; nevertheless the code warrants a check on the spacing against buckling of column longitudinal bars within the joint. If the column faces are confined on all four sides, ACI code allows the spacing of horizontal reinforcement to be relaxed up to 150 mm and EN code allows for the same to be either equal to least core dimension,  $b_o$ , or 150 mm whichever is lower.

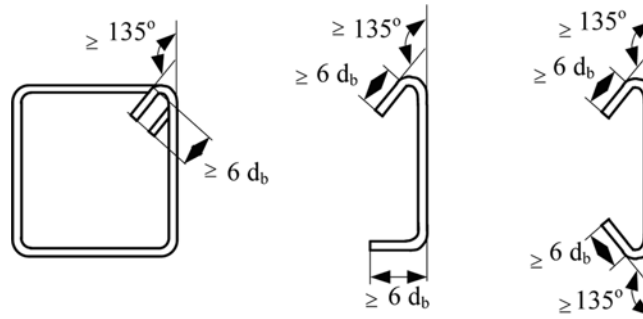

Fig. 11 Typical configurations of stirrup and cross-ties

The preferred shape of a single leg cross-tie would have a 135-degree bend at both ends. Since installation with such a configuration is difficult, ACI code allows standard 90-degree hook at one end of the cross tie with an extension not less than 6 times the diameter of the stirrup. But a 90-degree hook does not provide effective anchorage since it is not embedded in the confined column core. Hence, ACI code recommends alternate placement of a 90-degree hook on opposite faces of the column. However, in the case of exterior and corner connections, where the loss of cover could affect the anchorage of crossties at the 90-degree bend, it is recommended that only the 135-degree bend be used at the exterior face of the joint. However, NZS and EN codes prefer 135-degree bend at both ends. These two codes suggest an extension of 8 and 10 times the stirrup diameter respectively. Typical configurations are given in Fig. 11.

All three codes recommend for necessary anchorage to be provided in the form of hooks or any other positive anchorage system in exterior joints, where the beam bar terminates at the joint core.

#### 4. Conclusions

The behaviour and expected performance of flexural members of reinforced concrete moment resisting frames can be realised only when the joints are strong enough to sustain the severe forces set up under lateral loads. Hence, the design and detailing of joints is critical, especially in seismic conditions. The recommended procedures as per ACI 318M-02, NZS 3101:1995 and EN 1998-1:2003 codes of practice are appraised and compared. The three codes place high importance to provide adequate anchorage of longitudinal bars and confinement of core concrete in resisting shear.

In general, the depth of column in interior joint is required to be larger as compared to that in exterior joint from anchorage point of view. ACI code requires smaller column depth as compared to the other two codes for satisfying the anchorage conditions for interior and exterior joints. The NZS and EN codes account for column axial load in deciding minimum column depth from beam bar anchorage view point; however, the axial load effect on reducing the column dimension is only nominal.

The criteria for minimum flexural strength of columns required to avoid soft storey mechanism are comparable in the EN and ACI codes but much more stringent as per NZS code. As a result, anchorage requirement on member size is usually satisfied in the NZS design automatically.

The shear reinforcement required to ensure truss mechanism and to confine the core concrete



varies considerably between the three codes. ACI requires transverse reinforcement in proportion to the strength of the concrete where as NZS sets limits based on the level of nominal shear stress that is experienced by the joint core. EN provides shear reinforcement to confine the joint and to bring down the maximum tensile stress to design value. Also, the code gives a bound on the estimate of shear reinforcement to maintain the integrity of joint after diagonal cracking. The design shear reinforcement is decided based on the above two criteria.

NZS and EN codes require 60% of horizontal shear reinforcement as vertical shear reinforcement. All three codes accept the intermediate column bars as a part of vertical shear reinforcement.

The detailing requirements ensure adequate confinement of core concrete and preclude the buckling of longitudinal bars. The horizontal and vertical transverse reinforcements are to be distributed within the joint to resist the diagonal shear cracking and to contain the transverse tensile strain in core concrete. NZS and EN codes emphasize on provision of 135° hook on both ends of the cross-ties; whereas ACI code accepts 135° at one end and 90° hook at the other end and insists on proper placement of stirrups to provide effective confinement.

This study shows that there is a substantial variation in the codal provisions on beam column joints. This could possibly be on account of the fact that it is a relatively new area of knowledge; research on seismic response and design of beam column joints having begun only in the seventies. In general, the provisions of the NZS are most stringent, while the ACI code provisions are most liberal. For instance, the strong column – weak beam requirement is substantially more stringent in the NZS. The EN code has followed a somewhat middle path: in some respects it is more conservative like the NZS code, while in other respects it is closer to the ACI provisions. The EN codal provisions therefore indicate the road ahead and are more likely to offer a good model to follow for the countries in the process of developing their own codes.

## **Acknowledgements**

This work has been supported through a project entitled “Review of Building Codes and Preparation of Commentary and Handbooks” awarded to the Indian Institute of Technology Kanpur by the Gujarat State Disaster Management Authority, Gandhinagar through World Bank finances. The views and opinions expressed therein are those of the authors and not necessarily those of the GSDMA or the World Bank. The authors are grateful to Professors Bhupinder Singh of NIT Jalandhar and A. Meher Prasad of IIT Madras for reviewing early drafts of this paper. Discussions with Dr. Stefano Pampanin, University of Canterbury and his co-operation are gratefully acknowledged.

## **References**

- ACI 318M-02 (2002), “Building code requirements for structural concrete and commentary”, Reported by ACI Committee 318, *American Concrete Institute*, Farmington Hills, Michigan.
- EN 1998-1:2003, “General rules-specific rules for various materials and elements”, Eurocode 8: Design Provisions for Earthquake Resistant Structures.
- Hakuto, S., Park, R. and Tanaka, H. (1999), “Effect of deterioration of bond on beam bars passing through interior beam column joints on flexural strength and ductility”, *ACI Struct. J.*, **96**(5), 858-864.
- Hakuto, S., Park, R. and Tanaka, H. (2000), “Seismic load tests on interior and exterior beam-column joints with

- substandard reinforcing details”, *ACI Struct. J.*, **97**(1), 11-25.
- Ichinose, T. (1991), “Interaction between bond at beam bars and shear reinforcement in RC interior joints”, *Design of Beam-Column Joints for Seismic Resistance*, SP-123, American Concrete Institute, Farmington Hills, Mich., 379-400.
- Leon, R.T. (1990), “Shear strength and hysteretic behavior of beam-column joints”, *ACI Struct. J.*, **87**(1), 3-11.
- NZS 3101 (1995), “Concrete structures standard, Part 1 and 2, Code and commentary on the design of concrete structures”, New Zealand Standard, New Zealand.
- Pampanin, S., Calvi, G.M. and Moratti, M. (2002), “Seismic behaviour of R.C. beam column joints designed for gravity loads”, *12th European Conf. on Earthquake Engineering*, September, Paper No. 726.
- Park, R. and Hopkins, D.C. (1989), “United States/New Zealand/Japan/China collaborative research project on the seismic design of reinforced concrete beam-column-slab joints”, *Bulletin of the New Zealand National Society for Earthquake Engineering*, **22**(2), 122-126.
- Paulay, T. and Priestley, M.J.N. (1992), *Seismic Design of Reinforced Concrete and Masonry Buildings*, John Wiley and Sons
- Paulay, T., Park, R. and Priestley, M.J.N. (1978), “Reinforced concrete beam-column joints under seismic actions”, *J. ACI*, **75**(11), 585-593
- Shahrooz, B.M. and Moehle, J.P. (1990), “Seismic response and design of setback buildings”, *J. Struct. Eng.*, ASCE, **116**(5), 1423-1429.
- Uma, S.R. and Meher Prasad, A. (2006), “Seismic behaviour of beam column joints in moment resisting reinforced concrete frame structures”, *Indian Concrete Journal*, **80**(1), 33-42.

## Notation

$A_{ch}$	: cross-sectional area of rectangular section measured out-to-out of stirrups
$A_g$	: gross area of cross section
$A_{jh}, A_{jv}$	: total area of stirrups in the joint for horizontal and vertical shear respectively
$A_{sh}$	: total cross-sectional area of stirrups
$A_{s1}, A_{s2}$	: top (including flange width) and bottom reinforcements of beam respectively
$b_b, b_c$	: width of beam, width of column
$b_o$	: minimum core dimension of the column
$b_j$	: effective width of joint
$d_b$	: bar diameter
$f_c', f_{cd}$	: concrete cylinder compressive strength, design value of cylinder strength
$f_{cm}, f_{cd}$	: mean value of tensile strength of concrete, design tensile strength of concrete
$f_y, f_{yd}$	: characteristic yield strength, design yield strength of steel
$f_{yhd}$	: design value of yield strength of transverse reinforcement
$h_b, h_c$	: depth of beam, depth of column
$h_c''$	: column core dimension measured centre-to-centre of stirrups
hx	: max horizontal spacing of hoop or crosstie legs on all faces of the column
$h_{jc}$	: distance between extreme corner bars of the column
$h_{jw}$	: distance between top and bottom bars of the beam
$k_D$	: factor based on ductility class
$L_{dh}$	: horizontal development length
$l_c', l_c$	: the heights of the columns above and below the joint
$M_{ncs}, M_{nb}$	: nominal flexural strength of columns and beams respectively
$M_{Rcs}, M_{Rb}$	: design values of moments of resistance of columns and beams respectively
$N^*$	: design axial load at the ultimate limit state
s	: spacing of transverse reinforcement within the joint
$C_j$	: $V_{jh}/(V_{jx} + V_{jz})$
$V_{jx}, V_{jz}$	: total nominal shear force in x and z directions respectively
$\alpha_1$	: factor related to the cover of the longitudinal bar in exterior joint

$\alpha_2$	: factor related to the available stirrup confinement
$\alpha_b$	: the ratio of required to provided flexural reinforcement, taken as 1.0
$\alpha_f$	: one-way/two way frame loading factors as 1.0 and 0.85 respectively
$\alpha_0$	: overstrength for yield strength of steel at strain hardening as 1.25
$\alpha_p$	: factor to include beneficial effect of compression on column
$\alpha_1$	: factor related to top cover for beam bar in interior joint
$\beta$	: ratio of the compression to tension beam reinforcement at an exterior beam column joint, and is not to be taken larger than unity
$\gamma_{Rd}$	: model uncertainty factor
$\nu_d$	: normalized axial force ratio on column
$\rho'/\rho_{\max}$	: ratio of compression to maximum tension reinforcement